

ALSEYE

# A6

HIGH-COMFORT GAMING CHAIR

User Manual

Thanks for buying our product. Please read this manual carefully before installation and use as the manual said. In order to refer more information please take care of the manual.

### NOTES

1. Please avoid the fire, direct sunlight and wet environment.
2. Please do not put the chair on a high or unstable place, in case falling down.
3. Please put the chair on a flat ground.
4. Please pay attention to your kids when they are climbing the chair.
5. Please pay attention to the natural loosen of the bolts after long-term using, avoid sharp things scratch the chair.
6. Please avoid excessive tilt using in case falling down.

Product images and description only for reference purpose, please see the real products for more details.

## Mounting diagram for A6

Contains: Memory Head Pillow & Lumbar Pillow

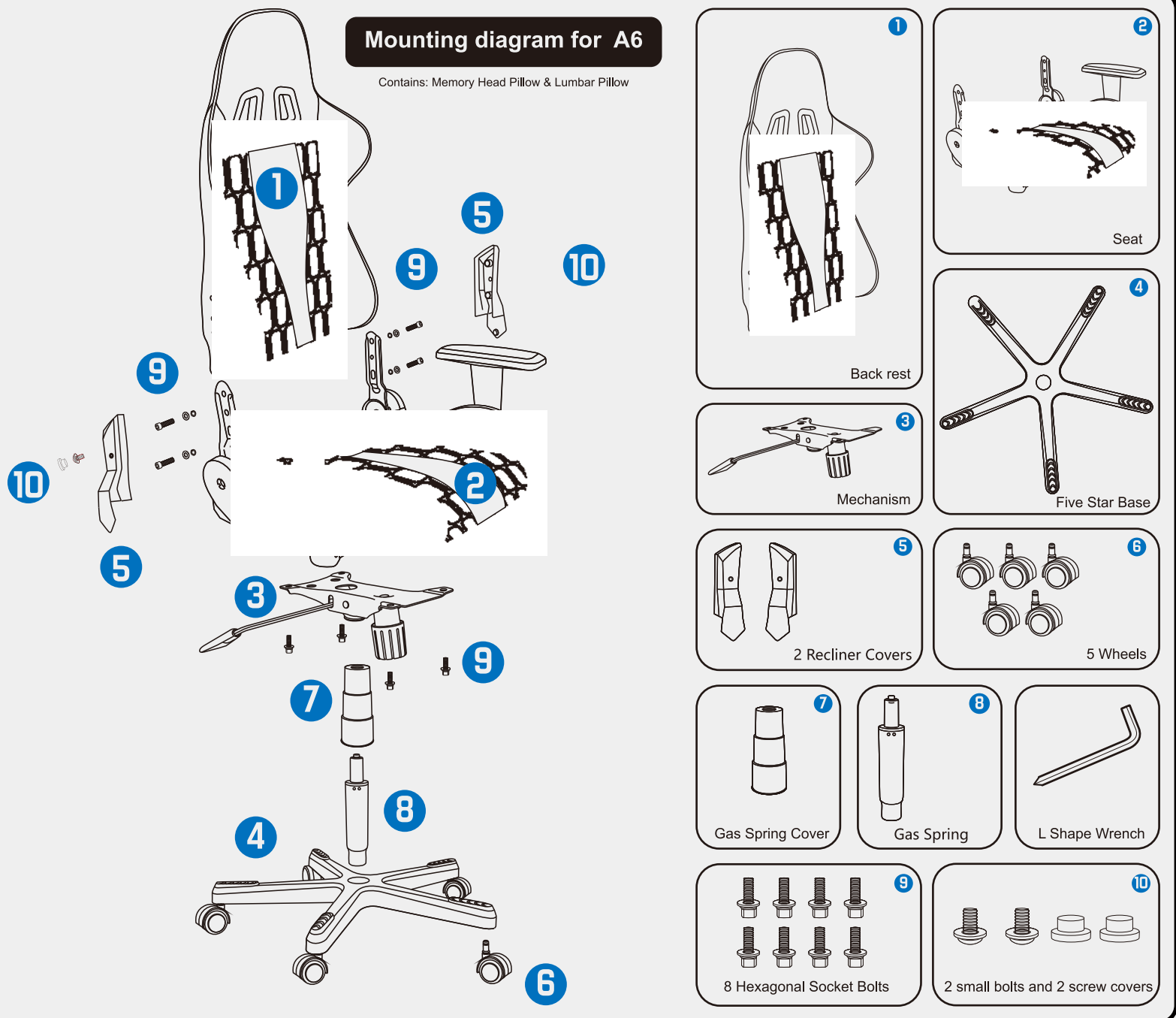

Front

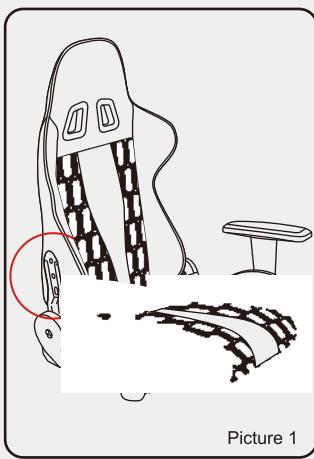
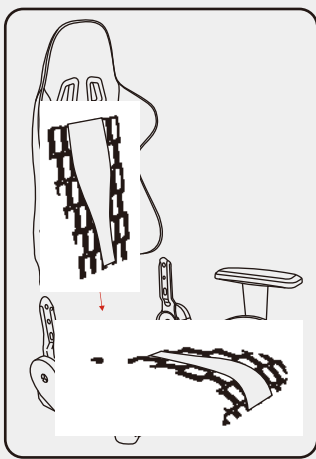

Picture 1

### STEP 1

**Put the back rest and seat together**  
Put the back rest and seat together as the picture 1. Please pay attention to the red marked place (left and right sides) which need aim at the bolts holes.

### STEP 2

**Lock the back rest and seat**  
Lock the 4 bolts on the left and right side as the picture step by step.

(Please remove the bolts that are pre-mounted on the backrest; two bolts are located on each side of the backrest. Place the backrest on the seat. Begin at the right side where the tilting handle is located. Screw both bolts on the right side half way in and then screw in the two bolts on the left side. Now tighten the bolts on both sides)

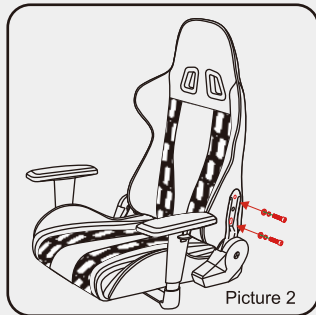

Picture 2

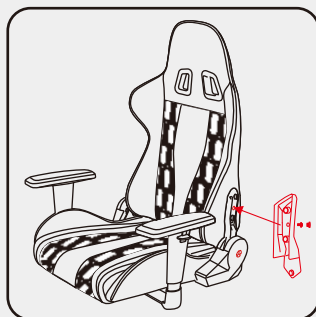

### STEP 3

**Install the recliner covers**

Attach the lower snap button first. Lock the screw into the hole on the recliner cover, and then attach the screw cover on it.

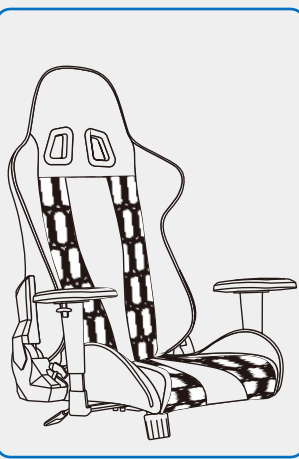
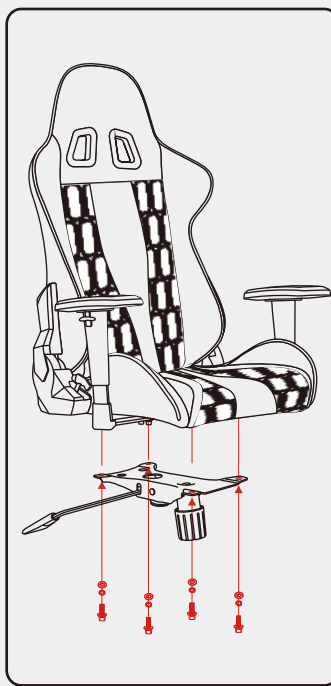

### STEP 4

**Install the mechanism**

Use the bolts to lock the mechanism and seat together, and make sure the bolts are screwed in tight.

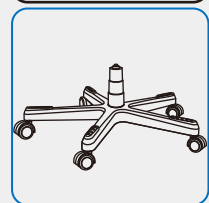
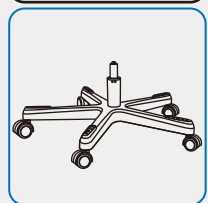
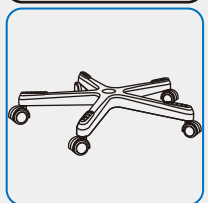
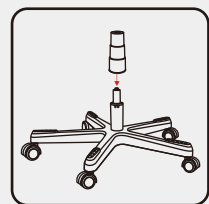
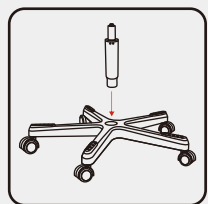
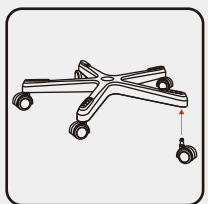

### STEP 5

**Install the wheel**

### STEP 6

**Install the gas spring**

### STEP 7

**Put on the gas spring cover**

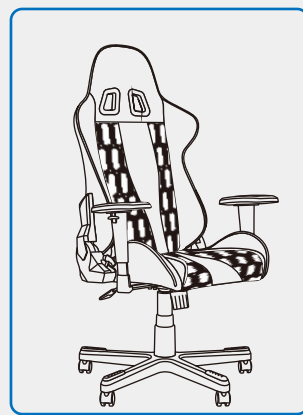
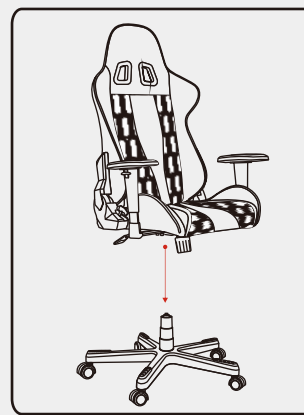

### STEP 8 Put the chair body on the gas spring

Aim at the top of gas spring and the hole of mechanism, then put the chair body down.

### Usage & Safety Instructions

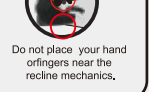
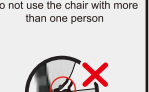
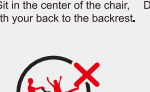

### ALSEYE CORPORATION LIMITED

B309, Block B, 3rd floor, Xindushi Plaza,  
NO.2008 Xinzhou South Road, Futian District,  
Shenzhen, Guangdong Province, China  
+86-0755-23600230  
support@alseyecorp.com  
www.alseyecorp.com



Made in China

Back